



# STANDARD

## ***C108/C108S/C108A***

***VHF HAND-HELD FM TRANSCEIVER***

## ***C408***

***UHF HAND-HELD FM TRANSCEIVER***

OWNER'S MANUAL

Downloaded by  
RadioAmateur.EU

MARANTZ JAPAN, INC.

PREPARATIONS

BASIC OPERATION

CONSTRUCTION

REPEATER

MEMORY

SCAN

CALL

DUAL WATCH

CHANNEL DISPLAY

VARIOUS FUNCTIONS IN SET MODE

---

*Thank you for purchasing our FM handheld transceiver.*

*This has been produced and shipped under our strict quality control and inspection.*

*If you have any questions on it, contact your dealer purchased it.*

*Please read this manual thoroughly and keep it.*

*This manual describes Models C108,C108S,C108A, and C408, centering around the C108.*

# CONTENTS

● PACKING LIST .....	2	● MEMORY .....	19
● OPTIONS .....	2	[1] About the Memory Functions .....	19
● PRECAUTIONS .....	3	[2] Memorization Method .....	20
● PREPARATIONS .....	5	[3] Calling the Memorized Frequency .....	21
[1] Attaching the Antenna .....	5	[4] Clearing the Memory .....	22
[2] Setting the Batteries .....	5	● SCAN .....	23
[3] Power Switch and Volume Control .....	6	[1] Types of Scan .....	23
[4] Adjusting the Communication Frequency .....	6	[2] Scanning Method .....	23
[5] Transmitting .....	7	● CALL .....	26
[6] Operation Sound of Each Key .....	8	[1] Using the CALL Key .....	26
● BASIC OPERATION .....	9	[2] Changing the CALL Frequency .....	27
[1] For Further Understanding of This Apparatus .....	9	● DUAL WATCH .....	27
[2] Key Operation of This Apparatus .....	10	[1] Types of Dual Watch .....	27
[3] Various Operations in SET Mode .....	11	[2] Dual Watching Method .....	27
● CONSTRUCTION .....	12	● CHANNEL DISPLAY .....	29
Top and Front .....	12	● VARIOUS FUNCTIONS IN SET MODE .....	30
Display Area .....	13	● INITIALIZATION (RESETTING) .....	38
● REPEATER .....	14	● TROUBLESHOOTING .....	39
[1] About the Repeater .....	14	● SPECIFICATIONS .....	41
[2] Using the Auto Repeater Mode(C408) .....	15		
[3] Setting the Repeater Mode .....	16		
[4] Setting the Offset Frequency .....	16		
[5] Setting the Tone Frequency (for Repeater)(C108A) .....	17		
[6] Setting the Reverse Function .....	18		
[7] Transmitting a Tone Burst (C108,C108S, C408) .....	18		

# PACKING LIST

# OPTIONS

When you open the carton, use the following packing list to make sure you have all the contents listed:

## Packing list

Main body .....	1
① Helical antenna .....	1
② Owner's manual (this manual) .....	1
③ Block diagram .....	1

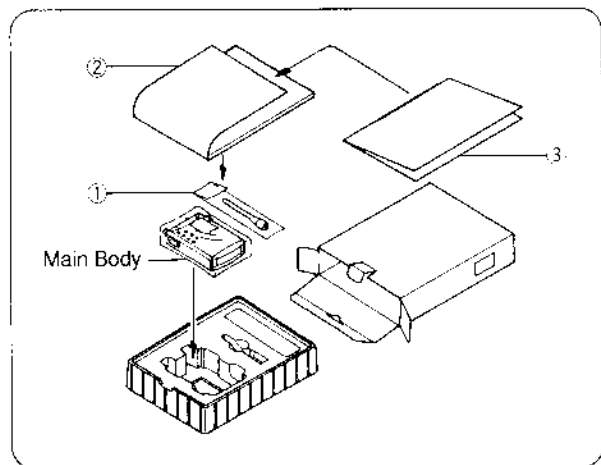

■ Abundant options are provided to enable wider applications of this apparatus. Read each instruction manual thoroughly for correct use.

## ● Microphone

CMP111 --- Microphone and speaker combination

CMP113 --- Tiepin type microphone

CMP115 --- Compact microphone and speaker combination

## ● Headset

CHP111 --- Headset with PTT

CHP150 --- Headset with VOX

## ● AC charger

CSA401E --- Desktop charger (for 220 V)

CSA401A --- Desktop charger (for 120 V)

## ● Soft case

CLC401 --- Soft case

CLC402 --- Fashionable soft case

## ● Rechargeable battery pack

CNB401 --- 2.4 V, 600 mAh

# PRECAUTIONS

Moist or humid place

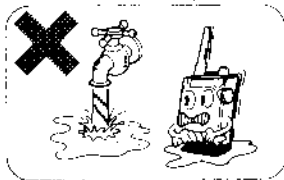

Vibrant or unstable place

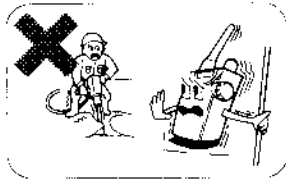

Dusty place

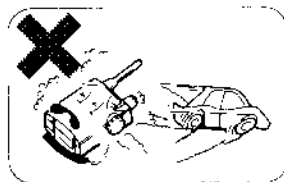

High temperature or direct sunshine

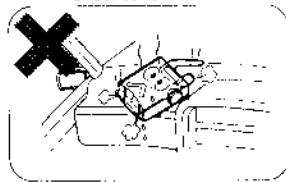

## ★ Do not disassemble !

- Never disassemble the transceiver.
- Do not touch the core or trimmer.

They have been adjusted to the best condition.



## ★ The transceiver runs only on the batteries !

- This apparatus is not designed to accept a supply of any external power. Be sure to use the batteries.  
A supply voltage range for this apparatus is 2.0 to 3.5 V.  
It is not available when the supply voltage is 1.8 V or less.  
It may lead to a trouble.



## ★ Do not transmit without attaching the antenna !

- The transceiver may be damaged if you try to transmit without attaching the antenna.
- Be sure to use the accessory antenna.

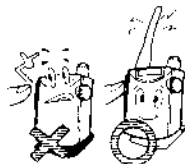

## ★ About the batteries !

- Be careful not to confuse the "+" and "-" poles of the batteries.

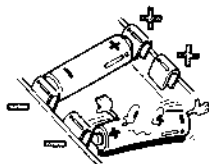

- Do not mix new and old batteries with each other.

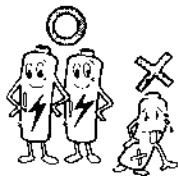

- Do not throw away used batteries into a fire.



## ★ Available batteries !

- AA-size manganese batteries
- AA-size alkaline batteries
- Do not use nickel-cadmium batteries.  
(For the rechargeable batteries, use optional CNB401.)

## ★ Use the rechargeable batteries after they are charged !

- Be sure to charge the rechargeable batteries before using them.
- Charge them properly, using a special charger.
- Make sure that the power switch of the radio is in the OFF position during charging.

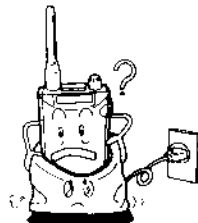

# PREPARATIONS

## [1] Attaching the Antenna

- Attach the antenna to an antenna terminal.

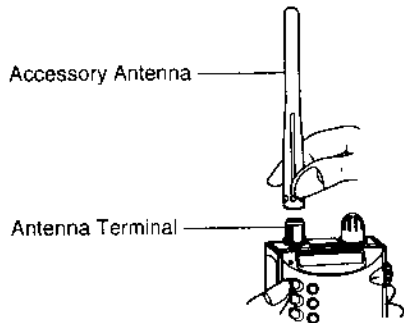

- Holding the bottom side of the antenna, turn it slowly in the clockwise direction to clamp it to the antenna terminal.

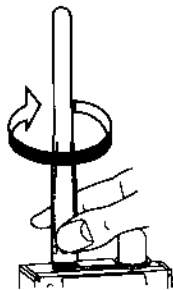

## [2] Setting the Batteries

- Open the battery case as shown in the figure.



- Set two AA-size batteries, paying attention to their direction.

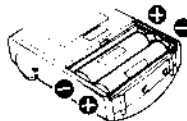

- Put back the battery case lid to close.

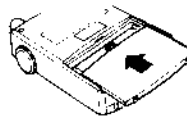

- When using the rechargeable battery pack, charge it with a special charger and set it in the main body, confirming its direction.

### Caution

When removing the batteries, turn off the POWER switch beforehand.

### [3] Power Switch and Volume Control

- Pressing the POWER key for 0.3 second turns on the power and displays a frequency in the display area.

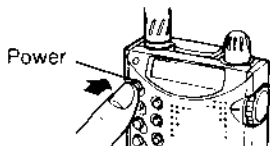

#### Caution

When a battery voltage has dropped to 1.8 V or less, the power is not turned on.

- The volume is increased by turning a volume control in the clockwise direction. Adjust it to your desired volume.

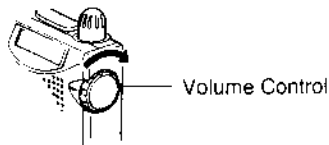

#### Advice

- For easier volume adjustment, it is recommended to adjust at the frequency (channel) where the other party can be heard or while pressing the MONI key.

### [4] Adjusting the Communication Frequency

- To adjust a communication frequency, use a rotary channel selector.
- The communication frequency is increased by turning the rotary channel selector clockwise and decreased by turning it counterclockwise.

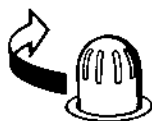

Increase the frequency

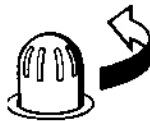

Decrease the frequency



## [5] Transmitting

- After setting the communication frequency, make sure that other station is not communicating at the set frequency, and then, press the PTT switch.

Now, the transceiver is ready to transmit.

### [Transmission: TX]

When transmission starts, the indicator is illuminated in red to indicate that transmission is under way.

Press the PTT switch

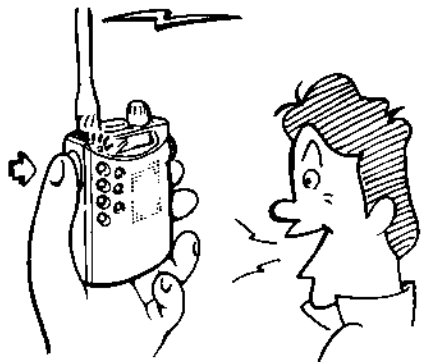

### [Reception: RX]

When reception starts, "BUSY" is displayed in the display area to indicate that reception is under way.

Release the PTT switch

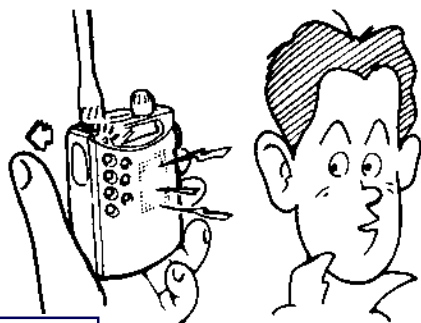

Downloaded by  
RadioAmateur.EU

## [6] Operation Sound (Beep Sound) of Each Key

- With a beep sound, you can confirm if each key was operated properly.
- The beep sound is classified as follows, depending on operations:
- When each operation key is operated properly, it emits a short "beep."

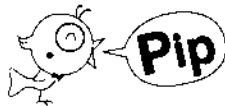

- When key operation is completed properly, it emits a long "beep."  
(For example, when a frequency write into the memory is completed)



- When the key is not operated properly or key operation is invalid, it emits a buzzing sound.



- When the auto power-off function is activated to turn off the power, it emits a short "beep" continuously.

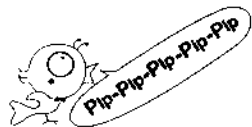

- When the function is cleared or the apparatus is reverted to the initial setting, it emits a puffing sound.



# BASIC OPERATION

## [1] For Further Understanding of This Apparatus

### Description of Each Mode

#### [VFO Mode]

When the frequency is displayed, but "M" is not, you are in the VFO mode. When you turn on the transceiver for the first time (referred to as the factory shipment state), the VFO mode takes effect. The frequency displayed in this mode is called a VFO frequency.

Upon shipment from the factory, it has been set to 146.00 (C108, C108A), 145.00 (C108S), or 433.00 (C408), respectively.

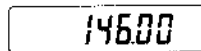

#### [CALL Mode]

When "C" is displayed, you are in the CALL mode. (For details, refer to Page 26)

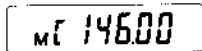

#### [Memory Mode]

When both frequency and memory address number are displayed, you are in the Memory mode (referred to as the memory call state).

If you press the V/M key in the VFO mode, you will be taken to the Memory mode. (For details, refer to page 19)

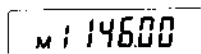

#### [SET Mode]

Of 20 kinds of commands displayed in the display area, one command is displayed. (21 kinds for the C108A and C408) (For details, refer to Page 11)

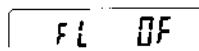

## [2] Key Operation of This Apparatus

### ■ POWER key



Used to turn on/off the power. The power is turned on/off by pressing it for 0.3 second or more.

### Caution

When the supply voltage dropped to 1.8 V or less, the power is not turned on.

### ■ LAMP key



Illumination switch for the display area. Once pressed, the display area will be illuminated for 5 seconds (if pressed again while it is illuminated, it will go off). When transmission is done, the illumination for the display area will go off.

### ■ SET key



Pressing this key effects the SET mode. Every time this key is pressed in the SET mode, each of the functions is displayed sequentially. Each function can be called faster by turning the rotary channel selector with this key held down.

(For details, refer to page 11)



### ■ MONI key



While this key is pressed, squelch is turned off (opened).

### ■ CALL key



Pressing this key effects the CALL mode and allows you to call a CALL frequency. Pressing again restores an original frequency. When this key is pressed during transmission, a 1,750 Hz tone burst signal is sent out (C408, C108, C108S) (For details, refer to Page 18)

### ■ SC key



Used to start/stop a scan.

Also available as a SET mode clear key.

### ■ V/M key



Used to change over from the Memory mode to VFO mode and vice versa. When you press this key while operating in other mode than the VFO mode, you will be taken to the VFO mode.

Key	Function	Ref. Pages
POWER	Turns on/off the power	6, 12
LAMP	Turns on/off the illumination of the display area	12
SET	Effects the SET mode and selects a function	11, 12
MONI	Turns on/off squelch control	12
CALL	Effects the CALL mode	12
SC	Starts/stops a scan	12
V/M	Changes over between the Memory and VFO modes, and cancels each mode	12

### [3] Various Operations in SET Mode

Set Menu	Initial Value	Function
FL	FL 0F	Turns on/off the key lock function
PL	PL 0F	Turns on/off PTT lock function
SHL	SHL 10	Selects squelch sensitivity; Hi/Lo
StL	StL 0F	Changes over MONI key operation
dL	dL 0F	Turns on the dual watch function
CLr	CLr 0F	Clears the memory
Ent	Ent 0F	Writes into the memory
MSM	MSM 0F	Sets/clears the memory scan memory
SA	SA 5R 0F	Turns on/off the battery save function and sets the save time
SCb	SCb 0F	Turns on/off a busy scan
St *1	St 5	Sets the tuning step
OF *2	OF 000	Sets the offset frequency
tF *3	tF 1000	Sets the tone frequency
rP	rP 0F	Turns on/off the Repeater mode
LL	LL 0F	Turns on/off the display area continuous illumination function
APO	APO 0F	Turns on/off the auto power-off function
FCH	FCH 0F	Turns on/off the function which enables the rotary channel selector in the key lock state.
bZ	bZ 0n	Turns on/off the beep
ArP *4	ArP 0n	Turns on/off the auto repeater function
bAC	bAC 0F	Replaces the frequency in the memory with VFO
CH	CH 0F	Changes over a display of the memory call state to a channel display
rS	rS 0F	Turns on/off the Reverse mode.

\* denotes a set value upon shipment from the factory.

- \* 1: An initial value is 5kHz (for C108,C108S,C408) and 10kHz (for C108A).
- \* 2: An initial value is 0.60 for the C108A,0.00 for the C108,C108S and 1.60 for the C408. (MHz)
- \* 3: C108A only    \* 4: C408 only

### [ ] Using the SET Mode

#### Procedure

- 1) Press the SET key. A set menu is displayed on the left side of the display area, and its set value to its right.

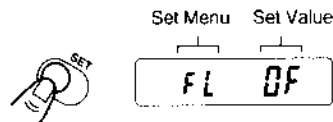

- 2) Every time the SET key is pressed, the set menu changes. Keep on pressing the SET key until your desired function appears.

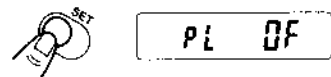

#### Advice

- The set menu can be fed forwardly or reversely by turning the rotary channel selector with the SET key held down. For details of the respective functions, refer to Page 30.

# CONSTRUCTION

## Top and Front

**MIC** (External microphone connection terminal).  
This is a connection terminal for our optional microphone and speaker (CMP111, CMP115), headset with PTT (CHP111), or headset with VOX (CHP150).

**Water-proof cap.**  
This is a water-proof cap for the MIC and SPK connection terminals.

**Antenna connection terminal (SMA type).**  
Attach the accessory antenna.

**TX indicator.**  
Illuminated during transmission.

**PTT switch (push-to-talk).**  
Selects transmission/reception.

**POWER key**

**LAMP key**

**SET key**

**MONI key**

**V/M key**

**SPK** (External speaker connection terminal).  
This is a connection terminal for our optional microphone and speaker (CMP111, CMP115), headset with PTT (CHP111), or headset with VOX (CHP150).  
A speaker with 8Ω load resistance or earphone is connected here to be used as an external speaker.

**CHANNEL** (Rotary channel selector knob).  
This is used to change the transmission/reception frequency or memory address.  
Also used to turn on/off or select the function in the SET mode.

**Display area**

**VOLUME** (Volume control knob).  
When you control the volume, hold down the MONI key. The volume is increased by turning clockwise.

**Speaker**

**CALL key**

**SC key**

**Microphone**

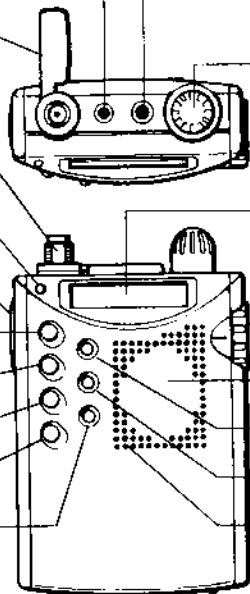

## Display Area

Displayed while the MONI key is pressed or when a signal is received. When SIL is turned off, a BUSY display goes off if you try to transmit when a signal is being received. When SIL is turned on, the BUSY display does not go off if you try to transmit when a signal is being received. Instead, you are informed that SIL is turned on.

Indicates the digit of tens when displaying the memory address 10-19. Also displayed in case of the program scan memory address L/H

PTT lock operation

Key lock operation

Memory/Call mode call

Displayed when the memory scan memory is turned on. The memory with this mark illuminated indicates that it has been specified as the memory scan memory.



Digit of 100 MHz

Digit of 10 MHz

Digit of 1 MHz

Digit of 100 kHz

Digit of 10 kHz

Displayed at Repeater mode

(+ shift)  
(- shift)

Digit of 1 kHz

Displayed at busy scan

Decimal point for tone frequency display

1 MHz dot (flashes during a scan)

100 MHz dot (illuminated at Reverse mode)

Displayed when the squelch position HI is set

Memory address number display

# REPEATER

## [1] About the Repeater

- Communicating by using a repeater station (automatic relay station) is called "repeater operation".
- Communication with a place where signals do not directly reach can be done by using the transceiver as a repeater station.
- In repeater operation, frequencies for transmission and reception are different. This difference is called the "offset frequency".
- Repeater operation is available in the areas where the repeater station is set up. Check up the transmission/reception frequency of the repeater station in each technical journal, etc.
- With this transceiver, when you transmit in the Repeater mode, the transmission frequency will be automatically reduced by the offset frequency.
- With this transceiver, when you press the CALL key while transmitting, the repeater station will be activated.

## Conventional Application (Simplex Application)

Transmission/Reception: 146.52 MHz    Transmission/Reception: 146.52 MHz

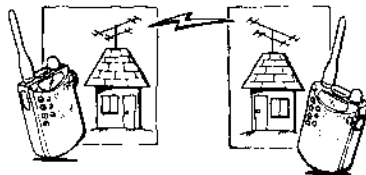

## Repeater Application (Example:)

When the offset frequency is set to 0.6 MHz and the shift to "-",  
[Frequency is lowered 0.6 MHz] [Repeater station] [Frequency is lowered 0.6 MHz]  
Transmission: 146.25 MHz    Transmission: 146.85 MHz    Transmission: 146.25 MHz  
Reception: 146.85 MHz    Reception: 146.25 MHz    Reception: 146.85 MHz

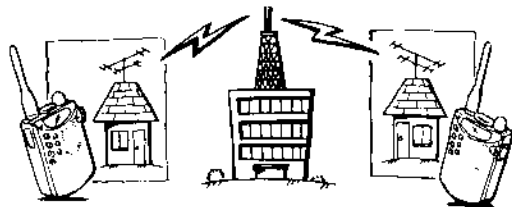

Transmits 1,750 Hz tone burst frequency  
or continuous tone signal

Transmits 1,750 Hz tone burst frequency  
or continuous tone signal



## [2] Using the Auto Repeater Mode (C408 only)

The Auto Repeater mode is a function provided for the C408. When the VFO frequency comes to the 435 MHz level, this function automatically turns on the Repeater mode to enable communications via the repeater.

This mode can be turned off in the Set mode.

(For details, refer to Page 37)

### Procedure

- 1) Adjust the VFO frequency to the frequency of the repeater station.

(Example: 435.50 MHz) The auto repeater function is activated to display "-." in the display area.

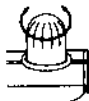

43550 ——— Display

- 2) Pressing the PTT switch starts transmission at the frequency which has been offset by -1.6 MHz.

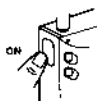

Reduced by 1.6 MHz

43390

### Advice

- (1) When you access the repeater station, you can receive its call sign (Morse code, etc.).
- (2) When the call sign of the repeater station cannot be received, the following causes are possible.

- The repeater station is too far.
- The offset frequency is not compatible with the repeater station.

### Caution

- This function is not available with the C108, C108S or C108A.

- 3) Hold down PTT switch and press the CALL key.

### [3] Setting the Repeater Mode

#### Procedure

- 1) Press the SET key to effect the Set mode and, display the set menu "rP."
- 2) Select "-" with the rotary channel selector.



- 3) Pressing the PTT switch starts transmission at the frequency lower by the offset frequency. If you select "+" in the step 2), transmission will be done at the frequency higher by the offset frequency.

#### Caution

If the offset frequency is out of the band, no transmitting is audible.

Check the offset frequency.

### [4] Setting the Offset Frequency

Transmission in the Repeater mode takes place at the frequency lower by the offset frequency.

This frequency is called the offset frequency.

Upon shipment from the factory, it has been set to 0.00 MHz (C108, C108S) 1.60MHz (C408) or 0.60 MHz (C108A).

#### Procedure

- 1) Press the SET key to effect the Set mode and, display the set menu "OF".
- 2) Set the offset frequency with the rotary channel selector.



- 3) Press the SC key to cancel the Set mode.



#### Advice

- The offset frequency can be set in the same manner as in [4] Adjusting the Communication Frequency on Page 6.

## [5] Setting the Tone Frequency (for Repeater)

This function is provided for the C108A only.

To communicate via the repeater station, send out a 100.0 Hz (setting upon shipment from the factory) tone together with a voice.

For the tone frequency, one of those shown in the right table can be set freely and changed in the following order.

### Procedure

- 1) Press the SET key to effect the Set mode and, display the set menu "tF."
- 2) Set the tone frequency with the rotary channel selector.

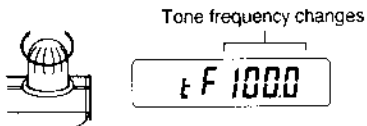

- 3) Press the SC key to cancel the Set mode.

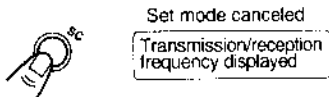

The following 24 kinds of tone frequencies can be set:

67.0	71.9	74.4	77.0	79.7	82.5
85.4	88.5	91.5	94.8	97.4	100.0
103.5	107.2	110.9	114.8	118.8	123.0
127.3	131.8	141.3	151.4	167.9	OFF

※ When OFF is set, no tone signal is sent out.

### Caution

This function is not available with the C108, C108S or C408.

Downloaded by  
RadioAmateur.EU

## [6] Setting the Reverse Function

The reverse function is to reverse the transmit and receive frequencies at the time of repeater application.

### Procedure

- 1) Press the SET key to effect the Set mode and, display the set menu "rS."
- 2) Change over from "OF" to "on" with the rotary channel selector.

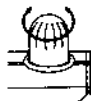

rS on

- 3) Press the SC key to cancel the Set mode.
- 4) Press the MONI key; while it is pressed, the transmission and reception frequencies are reversed and the 100 MHz dot is illuminated.

(For the functionalities of the MONI key, refer to Page 32)

### Caution

- This function is available only when the Repeater mode is set.
- When the transmission and reception frequencies are not reversed by setting the reverse function, it is likely that the offset frequency is still 0.00 MHz and has not been set.

## [7] Transmitting a Tone Burst

If you press the CALL key with the PTT switch held down, a 1,750 Hz tone burst will be sent out.

- This function is available with the C108, C108S and C408.

### Caution

This function is not provided for the C108A.

# MEMORY

## [1] About the Memory Functions

This transceiver can memorize a communication frequency, etc. It is convenient if you memorize the frequencies which are often used.

- Up to 20 kinds of frequencies can be memorized.
- Where to memorize is referred to a "memory address number" and represented as "Mx" ("x" denotes a number, 0 to 9).
- There are 20 memory address numbers, M0 to M9 and  $\bar{M}0$  to  $\bar{M}9$ .
- The following five kinds of information can be memorized in the memory address numbers.

- ① Transmission/reception frequency  
(communication frequency)
- ② Repeater function ON/OFF
- ③ Offset frequency
- ④ Tone frequency (only available with the C108A)
- ⑤ Memory scan memory setting

- In addition to the memory address numbers, program scan memories, "ML and MH," are also provided. (For program scan, refer to Page 24)

### Advice

- (1) In the VFO mode, pressing the V/M key effects the Memory mode (memory call state).  
If you press the V/M key in the Memory mode (memory call state), the VFO mode will be effected and you will be returned to the original frequency.
- (2) When the Memory mode (memory call state) is effected, "Mx" appears on the left side of the display area.
- (3) When no frequency has been memorized in the memory address number, "M" flashes, which indicates that the memory is being called.

## [2] Memorization Method

Frequency memorization method (writing)

[Example] Memorizing 145.10 MHz in M2

### Procedure

- 1) In the VFO mode, display the frequency you want to memorize.

Display the frequency you want to memorize

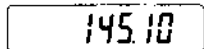

- 2) Press the V/M key to effect the memory call state, and display "M2" with the rotary channel selector.

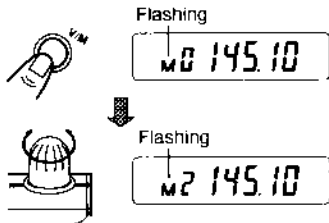

- 3) Press the SET key to effect the Set mode, and display the set menu "Ent."

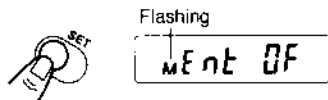

- 4) Turn the rotary channel selector. It emits a long beep and the display is changed to the memory call state, thus completing a memory write.

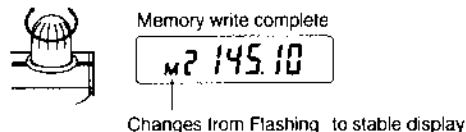

### Advice

- If you try to write to the memory address where "Mx" is being illuminated, the frequency in the memory will be rewritten.

## □ Other Memorization Methods

This transceiver can memorize repeater mode ON/OFF, offset frequency, tone frequency (C108A only), and memory scan memory setting as well as the transmission and reception frequencies.

The other information than the transmission and reception frequencies can be memorized by going through respective operation while calling the memory address where you want to memorize.

- ① Repeater mode ON/OFF  
(Refer to Page 16)
- ② Offset frequency  
(Refer to Page 16)
- ③ Tone frequency (available with only C108A)  
(Refer to Page 17)
- ④ Memory scan memory setting  
(Refer to Page 25)

## [3] Calling the Memorized Frequency

### Procedure

- 1) If "Mx" is not displayed, press the V/M key to effect the memory call state. ("x" denotes a number, 0 to 9)

### Caution

If "Mx" is displayed, the memory call state has been effected.

- 2) Turn the rotary channel selector to select your desired memory address number.

## [4] Clearing the Memory

[Example] Clearing 145.12 MHz in M7

### Procedure

- 1) In the memory call state, turn the rotary channel selector to display M7.

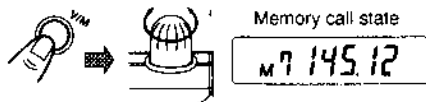

- 2) Press the SET key to effect the Set mode, and display the set menu "CLr."



- 3) Turning the rotary channel selector emits a long beep sound and displays the VFO frequency. ("M" starts flashing )

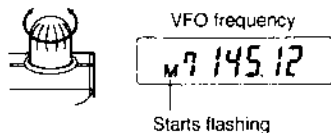

### Advice

- If the information such as repeater mode ON/OFF has been set in the memory address numbers, it will be also cleared simultaneously.
- If the memory is cleared, the cleared memory "Mx" will be initialized to the upon-shipment state.



# SCAN

## □ What Is Scan ?

Scan means an action to find a signal. When a scan starts, the reception frequency changes sequentially, a signal is found, its frequency is received.

## [1] Types of Scan

### ● Types of scan

There are two types of scan; pause scan and busy scan. They can be used selectively.

#### (1) Pause scan

When a signal is received, a scan is suspended temporarily. In 5 seconds after the scan was suspended, the scan is restarted even if the signal is being received.  
(When the signal disappears during suspension, the scan is restarted immediately.)

#### (2) Busy scan

A scan is suspended while receiving a signal. In 2 seconds after the signal disappeared, the scan is restarted.



### Advice

- Select the pause/busy in the Set mode.  
For details, refer to Page 33.

### ● Kinds of scan

This transceiver allows the following kinds of scan:

- (1) 1 MHz scan which scans within an arbitrary 1 MHz band
- (2) Program scan which scans a specified frequency range
- (3) Memory scan which sequentially scans the memorized frequencies
- (4) Memory scan memory which sequentially scans specified memory addresses

## [2] Scanning Method

### (1) 1 MHz scan

#### Procedure

- 1) Select the VFO mode.
- 2) Pressing the SC key starts a scan and causes the 1 MHz dot to flash.
- 3) Pressing the SC key stops the scan.

## (2) Program scan

### Procedure

- 1) Memorize the lower-limit scanning frequency in the memory address number ML.
- 2) Memorize the upper-limit scanning frequency in the memory address number MH.
- 3) Press the CALL key to effect the CALL mode.

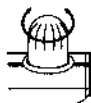

Memorizes lower-limit frequency

Memorizes upper-limit frequency



ML 146.00



Effects the program scan state

146.12

Flashing

- 4) Pressing the SC key starts scanning and causes the 1 MHz dot to flash.
- 5) Pressing the SC key again suspends scanning temporarily even if no electric wave is being received. If the SC key is pressed during suspension, scanning will be restarted.
- 6) Pressing the V/M key cancels scanning and returns you to the VFO mode.

### Advice

- (1) A scanning frequency step is the same as the tuning step.
- (2) A scanning direction can be changed by turning the rotary channel selector during scanning.

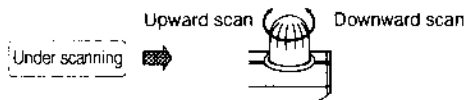

## (3) Memory scan

### Procedure

- 1) Press the V/M key to effect the Memory mode.
- 2) Pressing the SC key starts scanning and causes the 1 MHz dot to flash.
- 3) Pressing the SC key during a memory scan effects the Memory mode, and pressing the V/M key during a memory scan effects the VFO mode.

### Caution

When nothing has been memorized in any memory address number, the memory scan is not performed, emitting a buzzing sound.

#### (4) Memory scan memory

Setting the scanning memory (Giving the MSM mark "▼")

##### Procedure

- 1) Set the Memory mode.
- 2) Turn the rotary channel selector to display the memory address number to which you want to give the MSM mark.
- 3) Press the SET key to effect the Set mode, and display the set menu "MSM".

Displays the memory scanning frequency

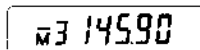

Set mode state

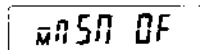

- 4) Turn the rotary channel selector to display "on", and then, display "▼".
- 5) Press the SC key to cancel the Set mode.
- 6) When setting in the multiple memory address numbers, repeat the steps 2) through 5).

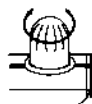

Memory scan memory setting complete

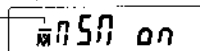

▼ displayed

#### Memory Scan Memory Method

##### Procedure

- 1) Select the VFO mode.
- 2) Press the SET key to effect the Set mode, and display the set menu "MSM".
- 3) Turn the rotary channel selector to display "on".

Set mode state

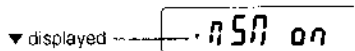

- 4) Set the Memory mode.
- 5) Pressing the SC key starts scanning only the memory marked MSM.
- 6) Pressing the SC key during memory scan memory effects the Memory mode, and pressing the V/M key during memory scan memory effects the VFO mode.

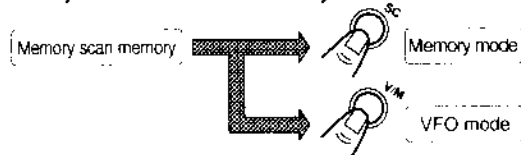

## Advice

- A scanning direction can be changed by turning the rotary channel selector during a scan.

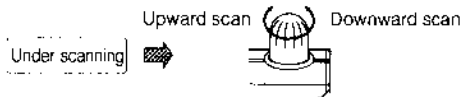

- There is the CALL memory provided, independent of the memory addresses, "M0 to M9,  $\bar{M}0$  to  $\bar{M}9$ ".
- Upon shipment from the factory, 146.00 MHz (for the C108 and C108A), 433.00 MHz (for the C408), or 145.00 MHz (C108S) has been memorized.
- The frequency memorized in the CALL memory can be changed.

## [1] Using the CALL Key

### Procedure

- 1) Press the CALL key.  
The CALL frequency is displayed.

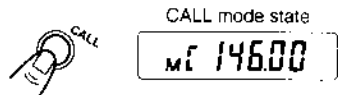

- 2) Press the CALL key.  
You are returned to the state existing prior to calling the CALL frequency.

### Advice

- If you turn the rotary channel selector when the CALL frequency is being displayed, the VFO frequency will be replaced by the CALL frequency.

## [2] Changing the CALL Frequency

### Procedure

- 1) Select the VFO mode.
- 2) Select a new frequency you want to set.
- 3) Press the CALL key to call the CALL frequency.
- 4) Press the SET key to effect the Set mode, and display the set menu "Ent".
- 5) Turn the rotary channel selector. With a long beep sound, the CALL frequency is rewritten and replaced by a new one.

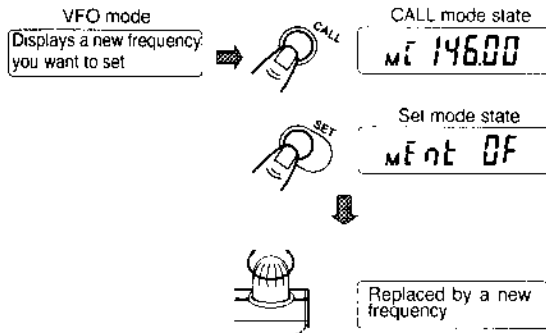

### Advice

- The information such as repeater mode ON/OFF, offset frequency, and tone frequency (C108A only) can be stored in the CALL memory.

The dual watch function is to receive another frequency (memory frequency) intermittently (at intervals of 3 seconds) while receiving one frequency (VFO frequency).

## [1] Types of Dual Watch

The dual watch function for this transceiver can select out of the following combinations of frequencies:

1. VFO frequency and the frequency in the memory address number M0
2. VFO frequency and the frequency in the specified memory address number
3. VFO frequency and CALL frequency

## [2] Dual Watching Method

1. Dual watch of the VFO frequency and the frequency in the memory address number M0

### Procedure

- 1) Select the VFO mode.
- 2) Select the Set mode, and display the set menu "dL".
- 3) Turning the rotary channel selector starts a dual watch.

### Caution

- When the frequency has not been memorized in the memory address number "M0", dual watching is not performed, emitting a buzzing sound.
2. Dual watch of the VFO frequency and the frequency in the specified memory address number

### Procedure

- 1) Select the **Memory mode** and call the memory address where you have memorized the frequency desired to be dual-watched.
- 2) Select the **Set mode** and display the set menu "dL".
- 3) Turning the rotary channel selector starts dual watching.

### Caution

- When the frequency has not been memorized in the called memory address number, dual watching is not performed, emitting a buzzing sound.

3. Dual watch of the VFO and CALL frequencies

### Procedure

- 1) Select the **CALL mode**.
- 2) Select the **Set mode** and display the set menu "dL".
- 3) Turning the rotary channel selector starts dual watching.

### □ Canceling the Dual Watch

To cancel the dual watch, press the SC key.

### Advice

- While receiving on the memory side, the dual watch is suspended temporarily. (When there is no more signal, the dual watch is restarted)
  - While receiving at the VFO frequency, the dual watch continues as it is.
- Although a receiving sound is discontinued, it is not a trouble.

# CHANNEL DISPLAY

## □ Changing the Memorized Frequency to Channel Number Display

This function changes a display of the memory call state to that of the channel number.

### Procedure

- 1) Press the SET key to effect the Set mode, and display the set menu "CH".
- 2) Turn the rotary channel selector to change over from "OF" to "on".

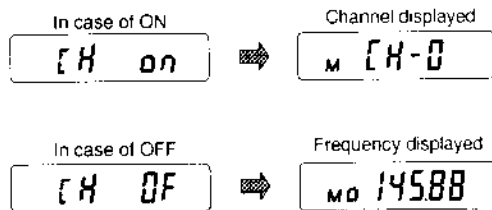
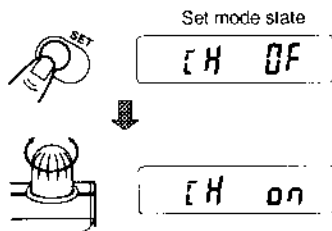

- 3) When the Memory mode is effected, a display of the memory address number and frequency is changed to that of the channel number.



### Advice

- The memory address number and channel number are same.

# VARIOUS FUNCTIONS IN SET MODE

## □ Using the Set Mode

※ The functions are described in the order of the list shown on Page 11.

### Procedure

1) Press the SET key. The set menu is displayed on the left side of the display area, and its set value on the right side.

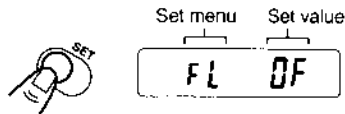

2) Every time the SET key is pressed, the set menu changes. Keep pressing the SET key until your desired function has been displayed.



### Advice

● The set menu can be changed over forward/backward by turning the rotary channel selector, with the SET key held down.

## [1] Turning on/off the Key Lock Function

### Procedure

1) Press the SET key to effect the Set mode, and display the set menu "FL".

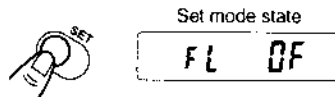

2) Turn the rotary channel selector to change from "OF" to "on". The key lock function is turned on to prevent unexpected operation or alteration of the frequency.

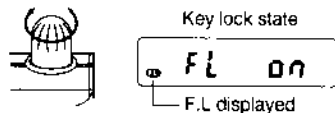

3) Press the SET key to effect the Set mode, and display the set menu "FL".

4) Turn the rotary channel selector to change from "on" to "OF". The key lock function is turned off.



## [2] Turning on/off the PTT Lock Function

### Procedure

1. Press the SET key to effect the Set mode, and display the set menu "PL".



Set mode state

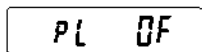

- 2) Turn the rotary channel selector to change from "OF" to "on". This disables transmission even if the PTT switch is pressed and prevents erroneous transmission.

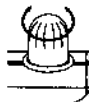

PTT lock state

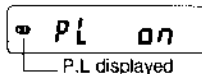

- 3) Press the SET key to effect the Set mode, and display the set menu "PL".
- 4) Turn the rotary channel selector to change from "on" to "OF ". The PTT lock function is turned off.

## [3] Changing over the Squelch Position (High/Low)

### Procedure

- 1) Press the SET key to effect the Set mode, and display the set menu "SHL".



Set mode state

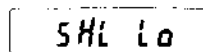

- 2) Turn the rotary channel selector to change from "Lo" to "Hi". This disables a voice output when you receive a signal too weak to catch what is communicated.

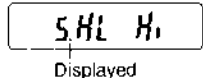
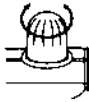

- 3) Press the SET key to effect the Set mode, and display the set menu "SHL".
- 4) Turn the rotary channel selector to change from "Hi" to "Lo".  
※ Normally, select "Lo" for use.  
(At "Hi", a weak signal cannot be received.)

### Advice

- When the squelch position is set to "Hi", a dot located at the lower right of the memory address number is illuminated.

## [4] Changing the MONI Key Operation

Normally, the MONI key can cancel squelch operation only while it is pressed.

If this function is turned on, squelch operation is turned off by pressing the MONI key once, and turned on by pressing it again.

### Procedure

- 1) Press the SET key to effect the Set mode, and display the set menu "StL".



Set mode state

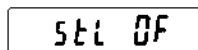

- 2) Turn the rotary channel selector to change from "OF" to "on".  
Pressing the MONI key opens the squelch.  
Pressing it again activates the squelch.
- 3) Press the SET key to effect the Set mode, and display the set menu "StL".
- 4) Turn the rotary channel selector to change from "on" to "OF".  
The squelch is opened only while the MONI key is pressed.

### Advice

- If the Reverse mode has been turned on, the MONI key is interlocked with the reverse function, and the transmission and reception frequencies are reversed while the squelch is

turned off.

## [5] Dual Watch Function

(Refer to Page 27)

## [6] Clearing the Memory

(Refer to Page 22)

## [7] Memorization Method

(Refer to Page 20)

## [8] Memory Scan Memory Method

(Refer to Page 25)

## [9] Turning on/off the Battery Save Function

- Use of this function minimizes battery consumption when waiting for reception.
- It allows intermittent reception at intervals of 1 (to 5 seconds).
- Upon shipment from the factory, it has been set to "OF".

### Procedure

- 1) Press the SET key to effect the Set mode, and display the set menu "SA".



Set mode state  
SA OF

- 2) Turn the rotary channel selector to set an intermittent time.

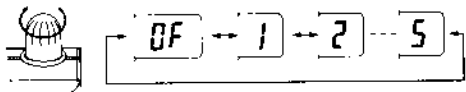

### Caution

- When this function is used, you may not be able to catch the first received word, but it is not a trouble.

## [10] Selecting the Busy Scan/Pause Scan

### Procedure

- 1) Press the SET key to effect the Set mode, and display the set menu "SCb".



Set mode state  
SCb OF

- 2) Turn the rotary channel selector to change from "OF" to "on". "B" is illuminated during a scan to indicate that it is a busy scan.



Busy scan state  
SCb on

- 3) Press the SET key to effect the Set mode, and display the set menu "SCb".
- 4) Turn the rotary channel selector to change from "on" to "OF". A pause scan starts from the next time.

## [11] Changing the Tuning Step

The tuning step refers to an amount of frequency by which the frequency changes when the rotary channel selector is clicked to the right (left).

With this transceiver, you can select it out of "5, 10, 12.5, (15), 20, 25, (30) and 50". (C408 is inhibited 15kHz and 30kHz step)  
Upon shipment from the factory, it has been set to 5 kHz (for the C108/C108S/C408) or 10 kHz (for the C108A).

### Procedure

- 1) Press the SET key to effect the Set mode, and display the set menu "St".

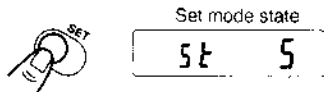

- 2) Turn the rotary channel selector to select your desired tuning step.

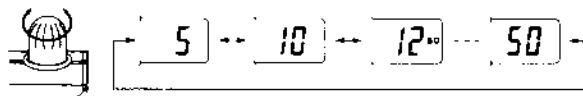

- 3) Press the SC key to restore the original display.  
※ When the tuning step is changed, the transmission and reception frequencies changes in the newly set tuning step, thereafter.

## [12] Setting the Offset Frequency (Refer to Page 16)

## [13] Setting the Tone Frequency (for Repeater) (Refer to Page 17)

## [14] Setting the Repeater Mode (Refer to Page 16)

## [15] Lamp Lock Function

Normally, pressing the LAMP key can illuminate the display area for 5 seconds.

If this function is turned on, the lamp will be turned on by pressing the LAMP key once and turned off by pressing it again.

### Procedure

- 1) Press the SET key to effect the Set mode, and display the set menu "LL".

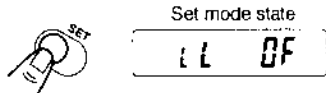

- 2) Turn the rotary channel selector to change from "OF" to "on". Pressing the LAMP key turns on the lamp. Pressing the key again turns off the lamp.
- 3) Press the SET key to effect the Set mode, and display the set menu "LL".
- 4) Turn the rotary channel selector to change from "on" to "OF". Pressing the LAMP key turns on the lamp for 5 seconds.

## [16] Turning on/off the Auto Power-off Function

This function is designed to prevent battery consumption as much as possible, which is triggered by forgetting to turn off the power. If this function is turned on, the power is turned off when this transceiver has not been operated or receiving (transmitting) a signal for 30 minutes or more.

### Procedure

- 1) Press the SET key to effect the Set mode, and display the set menu "APO".

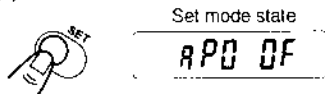

- 2) Turn the rotary channel selector to change from "OF" to "on". The auto power-off function is activated. About one minute before the power is turned off, a short beep continuously and "APO" appears in the display area. To turn on the power again, press the POWER key. (The APO function remains effective)
- 3) Press the SET key to effect the Set mode, and display the set menu "APO".
- 4) Turn the rotary channel selector to change from "on" to "OF". The auto power-off function is turned off.

## [17] Function to Enable Rotary Channel Selector in the Key Locked State

Normally, if the key lock function is turned on, all operations are disabled except canceling the key lock function. If this function is turned on before turning on the key lock function, however, you can change the frequency with the rotary channel selector even in the key locked state.

### Procedure

- 1) Press the SET key to effect the Set mode, and display the set menu "FCH".

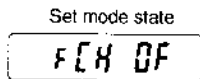

- 2) Turn the rotary channel selector to change from "OF" to "on".  
The rotary channel selector is enabled even in the key locked state.
- 3) Press the SET key to effect the Set mode, and display the set menu "FCH".
- 4) Turn the rotary channel selector to change from "on" to "OF".  
This function is turned off.

## [18] Turning on/off the Beep

### Procedure

- 1) Press the SET key to effect the Set mode, and display the set menu "bZ".

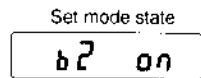

- 2) Turn the rotary channel selector to change from "on" to "OF".  
A key operation sound will not be heard any more.
- 3) Press the SET key to effect the Set mode, and display the set menu "bZ".
- 4) Turn the rotary channel selector to change from "OF" to "on".  
The key operation sound will be heard again.

## [19] Turning on/off the Auto Repeater Mode

This function is to automatically turn on the repeater function when the VFO frequency is at the 435 MHz level.

This function is provided only for the C408.

This function can be turned on/off as follows.

### Procedure

- 1) Press the SET key to effect the Set mode, and display the set menu "ArP".



Set mode state

ArP on

- 2) Turn the rotary channel selector to change from "on" to "OFF".  
The auto repeater function is turned off, and the repeater function will not be turned on even at the 435 MHz level.
- 3) Press the SET key to effect the Set mode, and display the set menu "ArP".
- 4) Turn the rotary channel selector to change from "OFF" to "on".  
The auto repeater function is turned on, and the Repeater mode will be effected at the 435 MHz level.

Downloaded by  
RadioAmateur.EU

## [20] Copying the Memory Frequency to VFO

You might want to slightly change the frequency in case of communications using the memory.

The frequency can be easily changed by using this function to copy the frequency in the memory to VFO.

### Procedure

- 1) Select the Memory mode and call the memory address number which you want to copy to VFO.
- 2) Press the SET key to effect the Set mode, and display the set menu "bAC".
- 3) Turn the rotary channel selector. With a long beep, the memory frequency is copied to VFO.  
(The memory frequency and Repeater mode ON/OFF are copied)

## [21] Changing the Memorized Frequency to Channel Number Display (Refer to Page 29)

## [22] Setting the Reverse Function (Refer to Page 18)

# INITIALIZATION (RESET)

- The reset switch is located in the battery storage area.

## Procedure

- 1) Open the battery cover on the back of the transceiver and remove the batteries.
- 2) There is a small hole located at the upper right in the battery storage area.

Using a pointed substance such as pen, insert and press.

- 3) When the radio is properly reset and the batteries are set, the power is turned on with a beep and the condition upon shipment from the factory is restored.

Display for the C108/C108A : 146.00

Display for the C408 : 433.00

Display for the C108S : 145.00

## Caution

When the radio is reset, all the information in the memory is cleared and the condition upon shipment from the factory is restored.

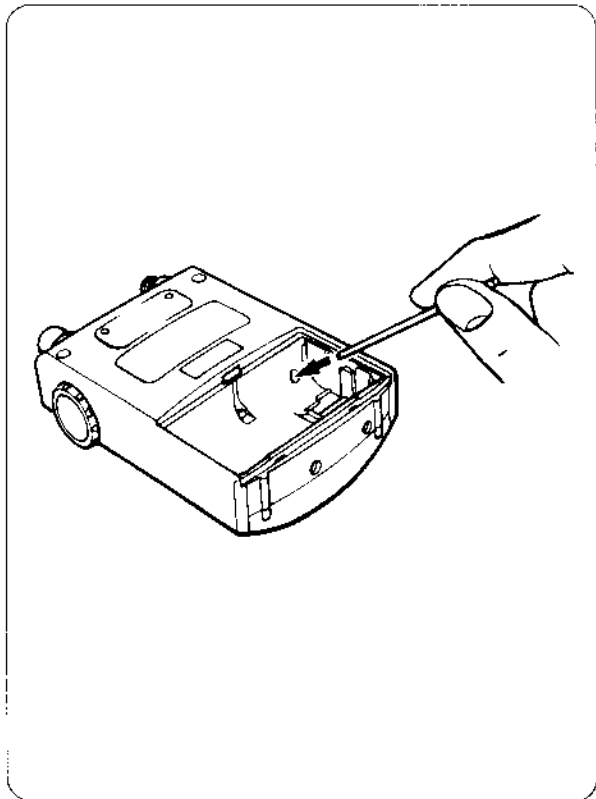



# TROUBLESHOOTING

---

## ★ The power cannot be turned on !

- ☆ Did you press the POWER key for 0.3 second or more ?
- ☆ Are the batteries properly set ?
- ☆ Have the batteries not run out ?

## ★ The display disappears when transmitted !

- ☆ The batteries have run out. Replace them with new ones.

## ★ Only strong signals are received !

- ☆ Is the antenna properly connected ?
- ☆ Is the squelch HI position mark (lower dot to the right of the memory number) not displayed in the display ?  
If the squelch level has been selected to HI position, set to "SHL LO" in the Set mode.

## ★ No signal is received !

- ☆ Is the volume control knob not set to a position of 0 ?  
Adjust to an adequate volume.

## ★ Will not transmit !

- ☆ When you press the PTT switch, does the display not disappear or flash ?  
The batteries have run out. Replace them with new one.
- ☆ Is "PL" not displayed in the display area ?  
In the Set mode, set to "PL OFF" and turn off the PTT lock function.

## ★ Not transmit at the displayed frequency !

- ☆ Is "+" or "-" not displayed in the display area ?  
In the repeater application, the transmission and reception frequencies are different.

## ★ The frequency cannot be changed ! (The key is not accepted)

- ☆ Is "FL" not displayed in the display area ?  
In the Set mode, set to "FL OFF" and turn off the frequency lock function.

---

★ It does not beep !

- ☆ Is the beep function not turned off ? In the Set mode, set to "bZ on".
- ☆ Is the volume control knob not set to a position of 0 ?  
Adjust to an adequate volume.

★ A noise does not stop !

- ☆ Is the squelch toggle function not turned on ?  
In the Set mode, set to "stl OFF".

★ Whenever the batteries are removed, all the information in the memory is cleared, initializing the display to 146.00 (for the C108/C108A), 433.00 (for the C408), or 145.00 (C108S).

- ☆ The built-in lithium battery has run out.  
Contact your dealer to have the battery replaced.

# SPECIFICATIONS

## ● General

### Frequency range:

C108	144.0 to 147.995 MHz
C108S	144.0 to 145.995 MHz
C108A	144.0 to 147.995 MHz
C408	430.0 to 439.995 MHz

Transmission type ..... F3

Microphone input impedance ..... 600  $\Omega$

Speaker impedance ..... 8  $\Omega$

Operating voltage range ..... 2.2 to 3.5 V

Rated voltage ..... 3.0 V

### Current consumption

At transmission (at 3.0 V) ..... Approx. 230 mA(C408)

..... Approx. 210 mA(C108/S/A)

At reception standby ..... Approx. 30 mA

At battery save ..... Approx. 8 mA

At auto power off (APO) ..... Approx. 0.5 mA

### Main body dimensions

(except the projections) ..... 58.0(W) x 80.0(H) x 25.0(D) mm

### Weight

(dry batteries, antenna included) ..... Approx. 130 g

## ● Receiver

Receiving method ..... Double superheterodyne

Intermediate ..... 1st IF 21.8 MHz (C108,C108S,C108A) ,  
23.05MHz (C408) 2nd IF 450 kHz

Receiving sensitivity ..... -10 dB  
(12 dB SINAD)

S/N at input of 0.5  $\mu$  V ..... 30 dB or more

Squelch opening sensitivity ..... -14 dB (0.1  $\mu$  V)

Audio output ..... Approx. 100 mW  
(at 8  $\Omega$ , 10 % distortion)

## ● Transmitter

Output ..... Approx. 230 mW

Modulation method ..... Reactance modulation

Max. frequency deviation .....  $\pm 5$  kHz

Spurious ratio ..... - 60 dB or more

Built-in microphone ..... Electret condenser microphone

■ The ratings and appearance of this transceiver are subject to change without prior notice due to improvement.

Downloaded by  
RadioAmateur.EU

